

Математическая морфология.
Электронный математический и медико-биологический журнал. - Т. 17. -
Вып. 2. - 2018. - URL:

<http://www.sci.rostelecom67.ru/user/sgma/MMORPH/TITL.HTM>
<http://www.sci.rostelecom67.ru/user/sgma/MMORPH/N-58-html/TITL-58.htm>
<http://www.sci.rostelecom67.ru/user/sgma/MMORPH/N-58-html/cont.htm>

CHIRAL PHYSICS OF THE HUMAN BRAIN

© 2018 Alexander Kholmanskiy^a, Nataliya Zaytseva^b

([kholmanskiy.doc](#))

Activation of chiral biomolecules by an external physical factor was explained by an increase in the effectiveness of melatonin biosynthesis in the epiphysis of a sleeping person at 2-3 o'clock in the morning. The rate of propagation of biogenic energy quanta over the lithosphere was estimated and their solar nature was suggested. The phenomenon of electromagnetic induction, the magnetic properties of sodium ions and the helicity of the myelin sheaths of nerve fibers were used to substantiate the inductive mechanism of saltatory conduction. The equivalent circuit of the neuron membrane was simulated by a sequence of oscillatory circuits, which allowed to lead the chirality factor into the algorithm of the operation of neural circuits. They modeled the structure and properties of an elementary quantum of energy possessing chirality and proposed rules for their assembly into particles and interactions with spins and magnetic moments of particles and chiral molecules. Assumed the participation of solar neutrino energy in the genesis of the morphofunctional dissymmetry of the human brain.

Key words: chirality; inductance; energyform; neuron; Ranvier; vibrational contour.

1. Introduction

The ideal prototype of an artificial intellectual system was and will be the human brain with its unique ability to heuristically think. The neurophysiology of this ability is based on the anatomical and functional features of the human brain. These include the organization and biochemistry of neural networks, as well as physical mechanisms for the formation, recognition and memorization of new patterns. The emergence and development of structural and functional features responsible for the mechanism of thinking can be associated with a mutation of the primacy genome and subsequent adaptation of its physiology to the action of the universal biogenic factor (UBF) at a certain stage of evolution. The main consequence of this mutation was the genesis of anatomy and physiology of the speech function. Speech acoustics, as an internal factor and UBF, as external, provided ontogeny and differentiation of a person's intellectual abilities in accordance with his phenotype [1]. At the same time, visual, olfactory and tactile sensory play their auxiliary role. The physical nature of UBF has not been established so far, however, it somehow affected the features of the mechanisms for processing and synthesizing new information in the human brain. Obviously, for their understanding, anatomical and biochemical studies of the brain must be accompanied by a study of the mechanisms of interaction of brain biosystems with

external and internal physical factors - electromagnetic (EM) and, possibly, neutrino nature: The fundamental dynamic idea of matter ... is so intertwined with our forms of thinking [2]; the principles of the brain are completely unusual, ... the dimensionality of his operations is beyond the scope of our ideas. ... the main thing in the activity of the brain is not a regulatory but constructive function [3]; The process of structuring ... is a spontaneous generation of an ordered sequence, a hierarchy of dynamic structures, or «energyforms» [4].

So far, the functional asymmetry of the brain, the chirality (optical activity) of biomolecules and fluid media of the brain, the cooperative effects in homogeneous biosystems, the phenomenon of EM induction and the impact on the brain of the sleeping person of geocosmic factors are not properly taken into account when studying and modeling the mechanism of thinking. Such factors include UBF, and the genesis of dissymmetry of living systems seems to be associated with it [5]. In modeling the physics of chiral systems and objects, energy quanta or particles possessing intrinsic chirality play an important role [6]. For their construction it is reasonable to use the simplest model of the dynamic form of matter - energy form (EF) [7]. Despite the fact that there are as yet no technical methods for direct recording of EF inside and outside the brain, their effect is manifested in the «vision» of the brain by dreams and pressure phosphophenes or magnetophosphenes [8]. EF are also involved in the generation of EM pulses detected by EEG and EMG methods [9].

2. Modeling of chiral energy quanta

The model of the simplest EF is constructed taking Maxwell's equations into account for the EM field (1) and extrapolations of the EM-induction phenomenon (Fig. 1):

$$\text{rot}\mathbf{E} = \partial\mathbf{B}/\partial t \text{ и } \text{rot}\mathbf{H} = \mathbf{j} + \partial\mathbf{D}/\partial t. \quad (1)$$

In (1), \mathbf{E} and \mathbf{B} are mutually orthogonal vectors of the strength of the vortex electric and magnetic fields, $\mathbf{D} = \epsilon_0\epsilon\mathbf{E}$, $\mathbf{B} = \mu_0\mu\mathbf{H}$, \mathbf{j} is the bias current, and the electrodynamic vacuum constant ($\epsilon_0\mu_0$) and the refractive index of the medium are related to the propagation velocities of the EM quanta in vacuum (C) and medium (V) by the relationships:

$$C = (\epsilon_0\mu_0)^{-1/2} \text{ и } V = C(\epsilon\mu)^{-1/2} = C/n. \quad (2)$$

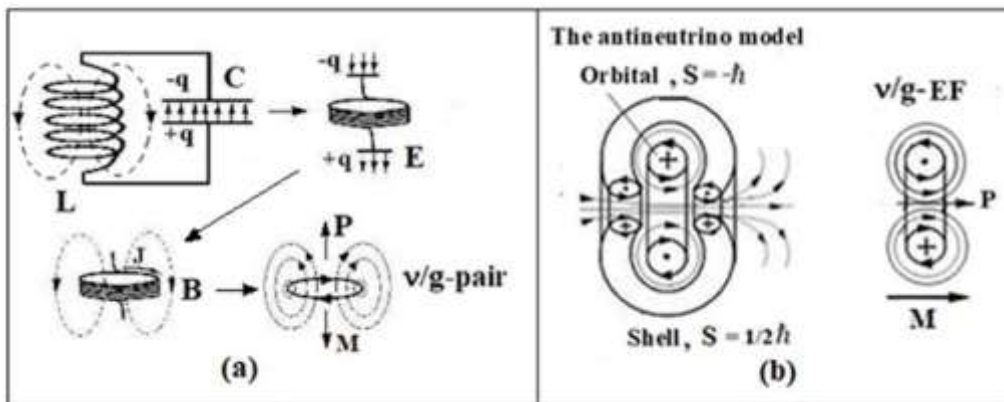

Fig. 1. (a) Vibrational contour, its transformed forms and their extrapolation to the level of the energy form (v/g-pair) having the impulse P , момент импульса M and the equivalent mass m_g . (b) Antineutrino models (spin $S = -\hbar/2$) and right-handed v/g-EF (P - momentum, M - angular momentum).

In Fig. 1 shows ν / g -pair simulating a left-handed photon or EM-vortex whose momentum and angular momentum are directed in opposite directions. From ν/g -pair it is possible to construct vortex models of elementary particles and nuclei [7]. For example, the antineutrino model will include a ν -shell and a g -orbital with spins $1/2$ and -1 , respectively (Fig. 1).

The assembly of ν/g -pair particles or EM energy quanta corresponding to the excited state of a molecule or a biosystem was represented by the condensation equation N of the ν/g -pair in the form [8]:

$$\frac{N\hbar C}{R_\nu} = \frac{\hbar C}{r_e} \quad (3)$$

In (3) R_ν refers to the characteristic size of a ν -vortex of a geocosmic scale, and r_e refers to the metric characteristics of an electron or electron orbitals, an atom, a molecule, or a molecular cluster. In this case, N can reach the Avogadro number.

The interaction of chiral EFs with a biosystem consisting of chiral molecules is realized analogously to the interaction of quasiparticles of magnons with nuclei and electrons having nonzero magnetic moments. Absorption by a particle or a system of EF particles will lead to a reorientation of the corresponding magnetic moment and will affect the spin-spin and spin-orbit interactions of chiral chromophores determining the anisotropy level of the electronic structure of the entire molecule and its chirality [7]. This will change the level of cooperation of chiral elements in homogeneous systems of molecular complexes and supramolecular ensembles in brain tissues. As a result, the chemical potential will increase, and the kinetics of biochemical reactions will become more dependent on the chirality of the molecules⁵.

3. Chiral physics of the epiphysis.

In the process of phylogenesis, an anatomical and physiological complex was formed in the human brain, regulating homeostasis in accordance with the circadian rhythm of day-night. The wakefulness regime is directly connected with the excitation of the visual system of the brain by the light of the Sun of the visible range. Similarly, the action of a UBF solar nature on brain biosystems at night can be responsible for the genesis of the physiology of sleep. Earth at night completely shields the effect on the biosphere of electromagnetic radiation, but is transparent to solar and cosmic neutrinos [10, 11]. In view of this, and the chirality of the neutrino, it can be accepted as the UBF. The physics of elementary particles [12] allows the decay of the solar neutrino in the interplanetary space to the isomorphic energy forms (ν / g -EF), consisting of the ν -shell and the g -orbitals (Fig. 2).

A key feature of sleep state physics is the biosynthesis in the epiphysis of the hormone melatonin (ME), the maximum content of which in the blood is observed at 2-3 o'clock in the morning [8]. The time dependence of the synthesis of ME is regulated by the paired suprachiasmatic nucleus (SCN), the main rhythm generator of the brain. SCNs have a neuronal connection to the retina of the eyes and the epiphysis [13] therefore during the day and when the eyes are illuminated, the SCN blocks the synthesis of ME, but initiates it in the dark due to its spontaneous activity, which does not cease even in the isolated state of the SCN. An important role in the activity of SCN is played by neuropeptide Y, whose structure is based on the α -helix of 36 amino acids [14].

The main stages of ME biosynthesis include the initiation of the suprachiasmatic nucleus into the epiphysis through the nerve endings of L-noradrenaline, which triggers the synthesis of the arylalkylamine-N-acetyltransferase (AAANAT) enzyme. AAANAT converts the L-tryptophan present in the epiphysis to serotonin, which, with the participation of the hydroxyindole-O-

methyltransferase enzyme, is converted to ME (Fig. 2). To the peculiarities of the epiphysis physics, in addition to the chirality of the participants in the biosynthesis of ME and the presence of α -helices from the sequences of chiral amino acids in the structure of enzymes, the dependence of the yield of biosynthesis of ME on the effect on the epiphysis of the alternating magnetic field (MF) is [15]. The limiting stage in the biosynthesis of ME is the initiation of L-noradrenaline synthesis of the enzyme AANAT, whose activity increases by two orders of magnitude [13] at night.

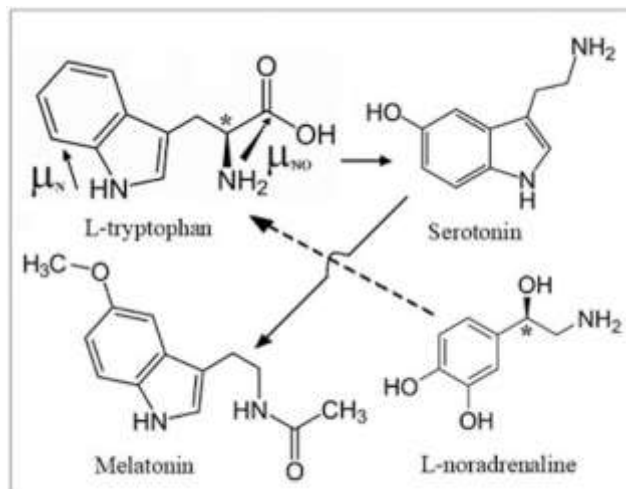

Fig. 2. Structures of the main participants in the biosynthesis of melatonin from L-tryptophan, directions of dipole moments of its fragments are marked by arrows ($\mu_{NO} \sim 10D$), and asterisks are chiral carbon atoms.

It was suggested in [11] that solar v/g-EFs flow around the earth along its lithosphere (Fig.3), which up to the boundary of the Makhrovichich (h) consists of $\sim 70\%$ silica containing equal amounts of quartz L and D crystals. On the night side of the Earth, counter flows v/g-EF, merge and exit to the surface, affecting the biosphere. Taking into account also the magnetosensitivity of the epiphysis, a maximum of ME content at 2-3 nights was associated with the maximum density of the v/g-EF effluent leaving the earth at that time. The shift of this maximum from 0 hours to 2-3 hours was explained by the rotation of the Earth (ω) and estimated the velocity (V_v) of the v/g-EF flux across the lithosphere as in the waveguide.

Taking into account the Earth's rotation speed ($V_E = \omega R_E$) and the slope of its rotation axis (23°), the time of motion (t) of the v/g-EF flows before their meeting at the point of the circle corresponding to 2 o'clock in the night was expressed by the equation:

$$t = \frac{\pi R_3 - \frac{1}{6}\pi R_E}{V_v - V_E \cos 23^\circ} = \frac{\pi R_3 + \frac{1}{6}\pi R_E}{V_v + V_E \cos 23^\circ},$$

the solution of which gave $V_v \sim 2.8$ km/s. Knowing V_v and t , we can estimate the displacement of the exit point of the v/g-EF in longitude (S) relative to the diametral point of the occurrence of the v/g-EF flow into the earth. It will be:

$$S \sim t V_E \sin 23^\circ \sim 0.07 \pi R_E \sim 1400 \text{ km or } \sim 13^\circ.$$

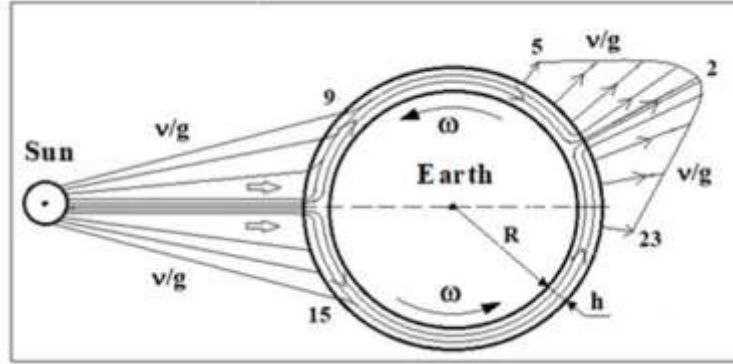

Fig. 3. Diagram of the flow of solar neutrino energy forms (ν/g) over the lithospheric layer $h \sim 10$ - 50 km thick; number - time of day in hours.

The obtained V_ν estimate of the ν/g -EF fluxes in the lithosphere is in good agreement with the magnitude of the propagation velocity of surface seismic waves over the Earth's crust and the probable nature of the quasiparticles (magnon and polaron) that can participate in the mechanism of ν/g -EF motion over the lithosphere [16]. The value of V_ν varies depending on the coordinates of the input of the ν/g -EF fluxes and the seasonal changes in the orientation of the Earth's rotation axis relative to the Sun. Corresponding changes in the density of the outgoing ν/g -EF flux affect the metabolism of the epiphysis and the physiological parameters of the reproductive function and psychophysics of a person that depend on it. The chirality factor in the biochemistry of the epiphysis will be transmitted along the neurohumoral links to other brain structures. Thus, UBF can participate in the generation of a functional brain asymmetry resource [11].

4. Induction mechanism of saltatory conduction of nerve fiber.

Chirality at the level of brain anatomy was manifested in the spirals of the myelin sheaths of nerve fibers of the central nervous system. It is not established what determines the wrapping mark of the spiral relative to the path from the nucleus to the terminals of the neuron and what is the distribution of the sign along the neurons of the right and left hemispheres. It does not take into account the helicity of the myelin sheath and in the sotor mechanism of nerve impulse transmission. These questions remain unheeded even in theoretical works [17, 18], modeling the generation processes in the interception of Ranvier photons with their subsequent propagation along the myelin and axon.

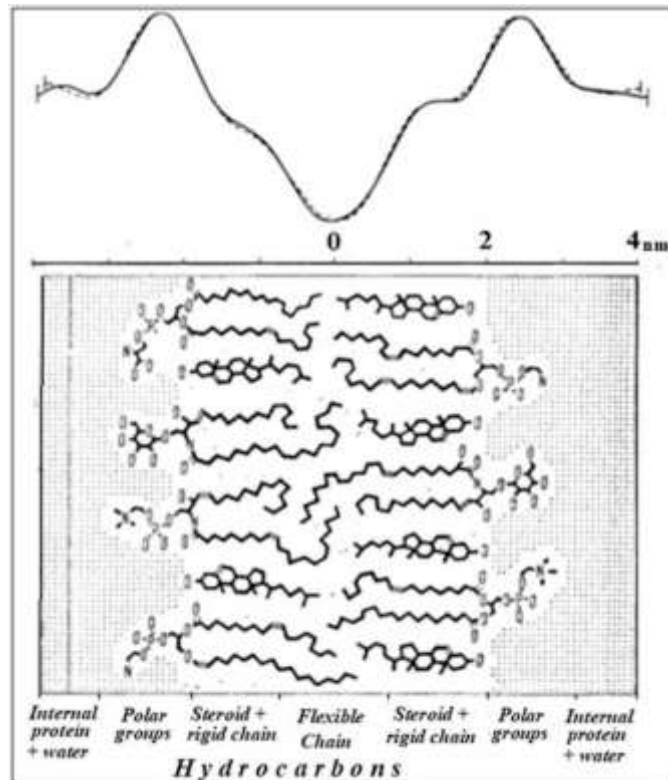

Fig. 4. Diagram of the myelin membrane structure. At the top are the electron density profiles for the ocular and sciatic nerve, from [19].

In work [8], a mechanism was proposed for the transmission of excitation through a myelinated fiber, based on the phenomenon of EM induction and taking into account the chemical structure of myelin (Fig. 4). His physical essence is explained by Fig. 5. The marginal structure of the myelin sheaths in the intercept region of Ranvier forms spiral coils of paranodal loops of about $1 \mu\text{m}$ in length, communicating with the axoplasm through special windows. Generation of the action potential (PD) in the Ranvier interception is mainly due to the increase in the axoplasm concentration of Na^+ , which diffuse into the paranodal region and polarize it and the axoplasm of the paranodal loops. In the myelin sheath, the displacement current (\mathbf{j}) is excited, the front of which moves along the coil turns and simultaneously along the cylinder of the myelin segment. In accordance with the Maxwell equations (1) with this displacement current, a vortex magnetic field will be associated, whose front will move along the axon as in the core with a velocity $V \sim C/n$. The sign of the myelin helix determines the direction of rotation of the current and, according to the rule of the right screw, the direction of the vector \mathbf{B} (Fig. 5).

The kinetics of ion currents and displacement currents in the axon, membrane, and paranodal loops of the myelin sheath correlates with the kinetics of growth and subsequent relaxation of the membrane potential. Since the phase of the PD growth lasts about 0.1 - 0.2 ms, and the relaxation time of the membrane potential is of the order of 1 ms [8], then the displacement currents corresponding to the phase of increase will be an order of magnitude greater than the relaxation currents. Thus, the generation of PDs in the Ranvier interception is associated with the induction in the nerve fiber of vortex EM quanta, similar to the v/g-EF in Fig. 1. It is possible that this is the main function of the end coils of myelin sheaths and incision spirals.

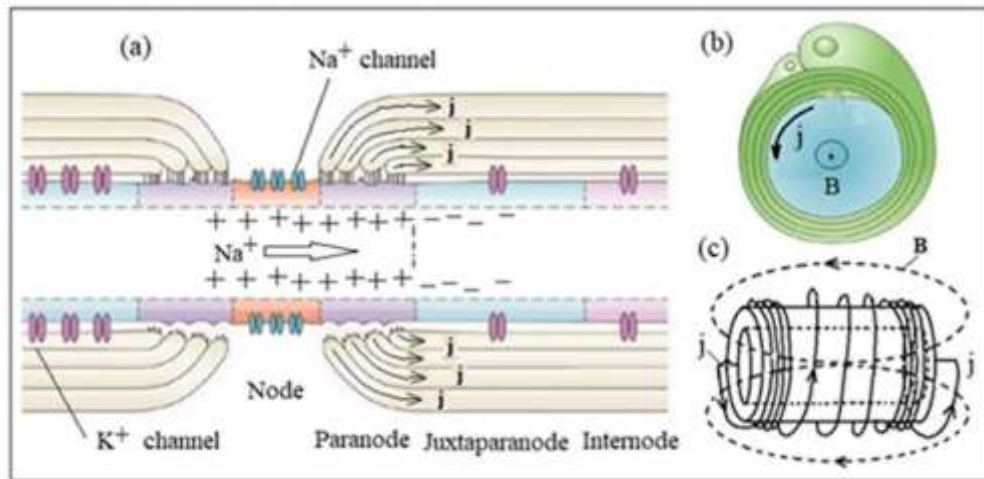

Fig. 5. Induction model of the saltator mechanism of nerve impulse transmission. Scheme of interception of Ranvier (a), myelin sheath (b) and myelin nerve segment (c). The arrow shows the diffusion of Na^+ , \mathbf{j} - the displacement currents, \mathbf{B} - the vortex magnetic field. The original figures (a) and (b) are taken from [18].

The direction of the vector of the flux density of the EM energy (the Poynting vector) will be determined by the sign of the spiral. This chirality factor of the neuron will ensure one-sided distribution of the EM-quantum and PD on the myelinated nerve. When the EM-quantum of the terminal coil of the myelin segment is reached, it will play the role of a stimulus for the generation of PD in the next interception of Ranvier.

This reaction is mainly due to sodium channels due to the fact that the magnetic moment of Na^+ is 6 times, and the magnetic susceptibility is 200 times larger than the corresponding values for K^+ [8]. In the inductive model of the saltatory conduction of the neuron, the speed of the spike motion will be limited by the process of current excitation in the end coils, whose time is of the order of 10^{-6} s ($1 \mu\text{m}:1 \text{ m/s}$). At the same time, the average transfer rate of PD from one end of the myelin segment to the other at a length of about $100 \mu\text{m}$ and will determine the rate of the saltatory mechanism of conductivity $\sim 100 \text{ m/s}$.

The inductive mechanism of the saltatory conduction of the nerve can be taken into account in the equivalent electrical circuit of the membrane [8], simulating the spiral myelin sheath with an inductor (Fig. 6). The transformation of the circuit into a circuit of parallel connected oscillatory circuits substantially extends the range of modeling the electrophysical properties of the neuron.

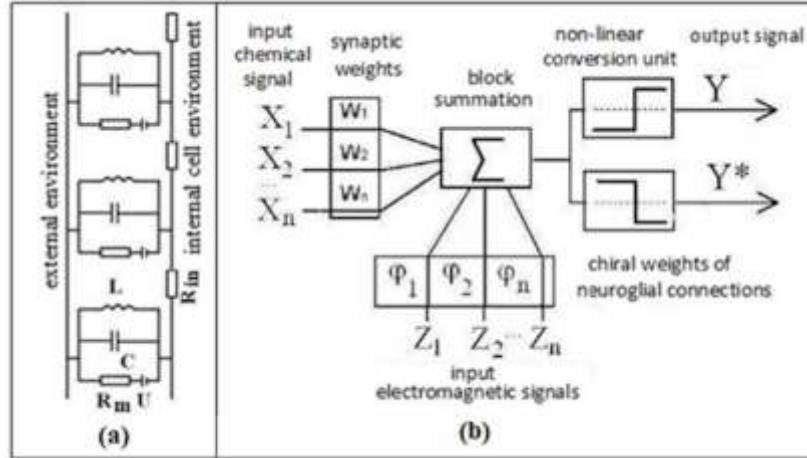

Fig. 6. (a) Modified electrical circuit of the nerve membrane. R_m , U - ion channel; C is the capacity of the membrane; L - inductance of glial membrane myelin helices; R_{in} - resistance of axoplasm. (b) Modified functional scheme of a formal neuron [21]. X_n - biochemical, Z_n - electrophysical factors of neuron activity; Y («yes»), Y^* («no») are analogues of the exciting and braking signals.

The element of inductance in the electrical circuit of the nerve membrane also makes it possible to model the chirality factor of the neuron and to associate it with the mechanism of the differentiation of nerve signals to stimulating and inhibitory ones. The combination of the chirality factor with the biochemical factor (synaptic connections) empowers the logical element of neural networks to encode the «yes» and «no» signals (Fig. 6).

5. Physics of integrative mechanisms of the brain.

Interactions of EF with each other and with the material of the brain obey the isoenergetic fractal-resonance rearrangements of the structures themselves of the EF and cooperative ensembles from the dynamic molecular-cellular elements of the brain [6-9]. The liquid media of the visual and auditory systems of the brain, as well as its cerebrospinal and circulatory system, which, in principle, possess chirality should be referred to the latter as the first [22]. The mechanism of heuristic thinking integrates the functions of individual organs responsible for the following processes: perception of internal and external signals, their processing, synthesis at the level of new patterns, recognition of novelty of information, evaluation of its significance and memorization.

With each stage of the mechanism of thinking, a definite dominant in the frequency spectrum of electrical oscillators of the heart and brain, extending from ~ 0.5 to ~ 100 Hz, will be associated [8, 9]. The rhythmic dynamics of these processes at the EM-level of the entire brain can be modeled by a chiral integral EM-scheme (Fig. 7). The common mechanism of excitation of internal rhythms of the brain is the phenomenon of EM-induction and the interaction of vibrational EM-circuits between themselves. For example, the alpha rhythm of the background electrical activity of the cortex maintains at a proper level the stability of the neocortex and thalamus connections. Right-left parts of the thalamus and the cortex of the hemispheres can be represented by dissimilar plates of two spherical capacitors, and the nerve connections between them (the radiance of the thalamus) will simulate ohmic connections and inductive coils in equivalent schemes of circuits operating at a frequency of alpha rhythm. The asymmetry of the inductive

elements of the EM contours of the right and left hemispheres can underlie the specialization of their cognitive functions.

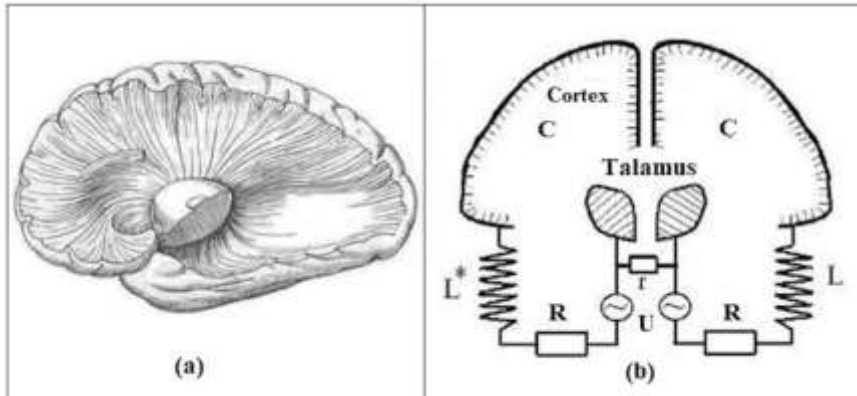

Fig. 7. (a) Radiation of the thalamus. (b) Equivalent oscillatory circuits modeling the alpha rhythms of the brain. L, L*, R - inductive and ohmic models of the radiance of the thalamus (sign *) means a mirror inversion of the chiral structures of the right hemisphere); r - interthalamic fusion; C and U are the capacitance and potential difference between the thalamus and the cortex.

6. Conclusion.

The evolution of natural science already has one dialectical leap in the form of a transition from classical physics to quantum physics. In the present work it was shown that in order to understand the mechanism of human heuristic thinking, it is necessary to deepen the physics of the brain to an elementary level of organization of matter in Maxwell and to take into account the chirality of external and internal morphofunctional factors. In parallel with this, fundamental physics will solve the neutrino problem, which physicists call the «window into a new physics» [23]. The discovery of this «window» may be explaining the key role of solar neutrino physics in the evolution of a homo sapiens.

References

1. Holmansky AS, Minakhin AA Factors of phylogenesis of human posture and morphogenesis. *Sciences*. 2012. **4**. 1-8. <http://naukovedenie.ru/PDF/48pvn412.pdf>
2. Maxwell, J. Selected papers on the theory of the electromagnetic field. M. 1954
3. Kaplan A. Ya. Harmony of the Big Bang. *Domestic notes*. 2014.2.123-36.
4. Khoruzhiy S. The discourses of the inner and the outer in the practices of oneself. *Moscow Psychotherapeutic Journal*. 2003. **3**. 5-25
5. Kizel V.A. Physical causes of dissymmetry of living systems. M.1985. 120.
6. Kholmanskiy A.S. Chirality and quantum effects as factors of morphogenesis. *Mathematical morphology: electronic mathematical and medico-biological journal*. 2010. 9. <http://sgma.alpha-design.ru/MMORPH/N-28-html/kholmanskiy-2/kholmanskiy-2.htm>
7. Kholmanskiy A.S. Elementary physics of ether. *Science and Peace*. 2016. **1** (4).19. [http://scienceph.ru/d/413259/d/science_and_world_no_4_\(32\),_april,_vol._i.pdf](http://scienceph.ru/d/413259/d/science_and_world_no_4_(32),_april,_vol._i.pdf)

8. Kholmanskiy A. Modeling of brain physics. *Mathematical morphology. Electronic mathematical and Medico-biological journal*. 2006. 5 (4); <http://new-idea.kulichki.net/pubfiles/180520162644.pdf>
9. Kholmanskiy AS, Minakhin AA Interconnection of electrical oscillations of the heart and brain. *Bulletin of St. Petersburg State University. Medicine*. 2018. **13** (2).
10. Kholmanskiy A.S. Galactic factor of spiritual evolution. *Asymmetry*. 2009. **3** (1). 47. http://cerebral-asymmetry.narod.ru/Asymmetry_1_2009.pdf
11. Kholmanskiy A.S. Dependence of the resource of functional asymmetry of the brain on external conditions. *Ibid*. 2009. 3 (1). 51-6: http://cerebral-asymmetry.narod.ru/Asymmetry_1_2009.pdf .
12. Klapdor-Kleingrothaus G.V., Staudt A. Non-accelerating physics of elementary particles. M. 1997.528.
13. Kovalzon VM Foundations of somnology: physiology and neurochemistry of the cycle «wakefulness-sleep». M. 2014.239.
14. Medanic M., Gillette M.U. Suprachiasmatic circadian pacemaker of the rat shows two windows of sensitivity to neuropeptide Y in vitro. *Brain Research*, 1993. **620** (2), 281-6.
15. Temur'yants N., Shekhotkin A., Magnitosensitivity of the epiphysis. *Biophysics*. 1998. **43**. 761.
16. Aleshkevich VA, Dedenko LG, Karavaev VA Fluctuations and waves. Moscow State University, 2001.
17. Kumar S. et al. Possible existence of optical communication channels in the brain. *Sci Rep*. 2016; 6: 36508. doi: 10.1038 / srep36508
18. Zangari A., Micheli D., Galeazzi R., Tozzi A. Node of Ranvier as an Array of Bio-Nanoantennas for Infrared Communication in Nerve Tissue. *Scientific Repots*. 2018. **8**. 539.
19. Volkenshtein M.V. Biophysics: M. 1988.592
20. Poliak S., Peles E. The local differentiation of myelinated axons at the nodes of Ranvier. *Nature Rev. Neuroscience*. 2003. **4**. 12. 968-80
21. Terekhov S.A. Lectures on the theory and applications of artificial neural networks. Snezhinsk, 1994-1998.
22. Kholmanskiy A. Chirality anomalies of water solutions of saccharides. *J. Mol. Liq*. 2016.**216**. 683.
23. Giunti C., Studenikin A. Neutrino electromagnetic interactions: a window to new physics. *Rev. Mod. Phys*. 2015. **87**.531

^aThe Scientific Center «Bemkom», 11, Shenkursky proezd, Moscow, 127340, Russian Federation

^bMoscow State Medical-Stomatological University, st. Delegate, 20, building 1. Moscow, 127473, Russian Federation

Поступила в редакцию 22.05.2018